

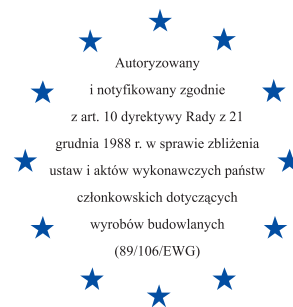

Instytut Techniki Budowlanej

Member of EOTA



European Technical Approval

ETA-11/0232

WK THERM ϕ 8

Nailed-in plastic anchors for fixing of external thermal insulation composite systems with rendering in concrete and in masonry

Łączniki tworzywowe do mocowania warstwy izolacyjnej ociepleń ścian zewnętrznych w podłożu betonowym i murowym



Europejska Organizacja ds. Aprobatach Technicznych
European Organisation for Technical Approvals

Europejska aprobatą techniczną została opracowana
w Zakładzie Aprobatach Technicznych
przez dr inż. Witolda MAKULSKIEGO

Projekt okładki: Ewa Kossakowska

GW V

Kopiowanie aprobaty technicznej
jest dozwolone jedynie w całości

Wykonano z oryginałów bez opracowania wydawniczego

© Copyright by Instytut Techniki Budowlanej
Warszawa 2012

ISBN 978-83-249-5518-3



Instytut Techniki Budowlanej

Dział Wydawniczy, 02-656 Warszawa, ul. Ksawerów 21, tel.: 22 843 35 19

Format: pdf

Wydano w marcu 2012 r.

Zam. 279/2012

INSTYTUT TECHNIKI BUDOWLANEJ
PL 00-611 WARSZAWA
ul. FILTROWA 1
tel.: (48 22) 825-04-71;
(48 22) 825-76-55;
fax: (48 22) 825-52-86;
www.itb.pl



Członek EOTA

European Technical Approval

ETA-11/0232

English language translation - the original version is in Polish language

Nazwa handlowa

Trade name

WK THERM ϕ 8

WK THERM ϕ 8

Właściciel aprobaty

Holder of approval

KLIMAS WKREŃ-MET Sp. z o.o.

ul. Wincentego Witosa 135/137

Kuźnica Kiedrzyńska

PL 42-233 Mykanów

Poland

Rodzaj i przeznaczenie wyrobu

*Generic type and use
of construction products*

**Łączniki tworzywowe do mocowania warstwy
izolacyjnej ociepleń ścian zewnętrznych
w podłożu betonowym i murowym**

*Nailed-in plastic anchors for fixing of external thermal
insulation composite systems with rendering in concrete
and in masonry*

Termin ważności

Valid

od

from

do

to

07. 09. 2011

07. 09. 2016

Zakład produkcyjny

Manufacturing plant

KLIMAS WKREŃ-MET Sp. z o.o.

ul. Warszawska 2, Wanaty

PL 42-260 Kamienica Polska

Poland

Niniejsza Europejska

Aprobata Techniczna zawiera

*This European Technical
Approval contains*

19 stron, w tym 6 Załączników

19 pages including 6 Annexes



Europejska Organizacja ds. Aprobatach Technicznych

European Organisation for Technical Approvals

I LEGAL BASES AND GENERAL CONDITIONS

1. This European Technical Approval is issued by Instytut Techniki Budowlanej in accordance with:
 - Council Directive 89/106/EEC of 21 December 1988 on the approximation of laws, regulations and administrative provisions of Member States relating to construction products¹, amended by the Council Directive 93/68/EEC of 22 July 1993²;
 - ustawa z dnia 16 kwietnia 2004 r. o wyrobach budowlanych (law on construction products from 16th April 2004)³;
 - rozporządzenie Ministra Infrastruktury z dnia 14 października 2004 r. w sprawie europejskich aprobat technicznych oraz polskich jednostek organizacyjnych upoważnionych do ich wydawania (regulation of Ministry of Infrastructure of 14th October 2004 on the European Technical Approvals and Polish bodies entitled to issue them)⁴;
 - Common Procedural Rules for Requesting, Preparing and the Granting of European Technical Approvals set out in the Annex of Commission Decision 94/23/EC⁵;
 - Guideline for European Technical Approval of „*Plastic Anchors for Fixing of External Thermal Insulation Composite Systems with Rendering*”, ETAG 014, Edition January 2002 (amended December 2008).
2. Instytut Techniki Budowlanej is authorized to check whether the provisions of this European Technical Approval are met. Checking may take place in the manufacturing plant. Nevertheless, the responsibility for the conformity of the products to the European Technical Approval and for their fitness for the intended use remains with the holder of the European Technical Approval.
3. This European Technical Approval is not to be transferred to manufacturers or agents of manufacturers other than those indicated on page 1, or manufacturing plants other than those indicated on page 1 of this European Technical Approval.
4. This European Technical Approval may be withdrawn by Instytut Techniki Budowlanej, in particular after information by the Commission on the basis of Article 5 (1) of Council Directive 89/106/EEC.
5. Reproduction of this European Technical Approval including transmission by electronic means shall be in full. However, partial reproduction can be made with the written consent of Instytut Techniki Budowlanej. In this case partial reproduction has to be designated as such. Texts and drawings of advertising brochures shall not contradict or misuse the European Technical Approval.
6. The European Technical Approval is issued by the approval body in its official language. This version corresponds to the version circulated within EOTA. Translations into other languages have to be designated as such.

¹ Official Journal of the European Communities № L 40, 11.02.1989, p. 12

² Official Journal of the European Communities № L 220, 30.08.1993, p. 1

³ Official Journal of Polish Republic № 92/2004, pos. 881

⁴ Official Journal of Polish Republic № 237/2004, pos. 2375

⁵ Official Journal of the European Communities № L 17, 20.01.1994, p. 34

II SPECIFIC CONDITIONS OF THE EUROPEAN TECHNICAL APPROVAL

1 Definition of product and intended use

1.1 Definition of product

The WKTHERM ϕ 8 nailed-in plastic anchor consists of an anchor sleeve with a plate made of polyethylene and an accompanying specific nail as an expansion pin made of the galvanised steel with a head covered by polyamide as a plastic coat.

The WKTHERM ϕ 8 anchor may in addition be combined with the plate TDX-90 or TDX-140 shown in Annexes 5 and 6.

The installed anchor is shown in Annex 1.

1.2 Intended use

The anchors are intended to be used for anchorages for which requirements for safety in use in the sense of the Essential Requirement 4 of Council Directive 89/106/EEC shall be fulfilled and failure of anchorages made with these products would cause low risk to human life. The anchors are to be used only as multiple fixing for the anchorage of bonded external thermal insulation composite systems (ETICS) according to ETAG 004 in concrete and in masonry. The substrate (base material) shall consist of concrete or masonry walls according to Table 5, Annex 4.

The anchor may only be used for transmission of wind suction loads and shall not be used for the transmission of dead loads of the thermal insulation composite system. The dead loads have to be transmitted by the bonding of the thermal insulation composite system.

The provisions made in this European Technical Approval are based on an assumed working life of the anchor of 25 years. The indications given on the working life cannot be interpreted as a guarantee given by the producer or Approval Body, but are to be regarded only as a means for choosing the right products in relation to the expected economically reasonable working life of the works.

2 Characteristics of product and methods of verification

2.1 Characteristics of product

The anchors correspond to the drawings and information given in Annexes 1 and 2. The characteristic material values, dimensions and tolerances of the anchor not indicated in these Annexes shall correspond to the respective values laid down in the technical documentation⁶ of this European Technical Approval.

The characteristic values for the design of the anchorages are given in Annexes 3 and 4.

⁶ The technical documentation of this European Technical Approval is deposited at Instytut Techniki Budowlanej and, as far as relevant for the tasks of the approved body involved in the attestation of conformity procedure, may be handed over only to the approved body involved.

Each anchor is to be marked with identification mark of the producer, the sleeve type, sleeve diameter and sleeve length (anchor length). The marking is imprinted on each anchor sleeve.

The minimum effective anchorage depth shall be marked.

The anchor shall only be packaged and supplied as a complete unit. Each package is to be marked with the type of the anchor, i.e. WK THERM ϕ 8.

2.2 Methods of verification

The assessment of the fitness of the anchors for the intended use in relation to the requirements for safety in use in the sense of the Essential Requirement 4 has been made in compliance with:

- the Guideline for European Technical Approval of „*Plastic Anchors for Fixing of External Thermal Insulation Composite Systems with Rendering*”, ETAG 014, based on the use categories A, B and C,
- the EOTA Technical Report TR 025 “*Determination of point thermal transmittance of plastic anchors for the anchorage of external thermal insulation composite systems (ETICS)*”,
- the EOTA Technical Report TR 026 “*Evaluation of plate stiffness from plastic anchors for fixing of external thermal insulation composite systems with rendering (ETICS)*”.

In addition to the specific clauses relating to dangerous substances contained in this ETA, there may be other requirements applicable to the products falling within its scope (e.g. transposed European legislation and national laws, regulations and administrative provisions). In order to meet the provisions of the Construction Products Directive, these requirements need also to be complied with, when and where they apply.

3 Evaluation of conformity of the product and CE-marking

3.1 Attestation of conformity system

The system of attestation of conformity 2 (ii) (allocated to system 2+) according to Council Directive 89/106/EEC Annex III provides:

(a) Tasks of the manufacturer:

- (1) initial type-testing of the product,
- (2) factory production control,
- (3) testing of samples taken at the factory by the manufacturer in accordance with a prescribed test plan.

(b) Tasks of the approved body:

- (4) certification of factory production control on the basis of:
 - initial inspection of factory and of factory production control,
 - continuous surveillance, assessment and approval of factory production control.

3.2 Responsibilities

3.2.1 Tasks of the manufacturer; factory production control

The manufacturer has a factory production control system in the plant and exercises permanent internal control of production. All the elements, requirements and provisions adopted by the manufacturer are documented in a systematic manner in the form of written policies and procedures. The factory production control system ensures that the product is in conformity with the European Technical Approval.

The manufacturer may only use raw materials supplied with the relevant inspection documents as laid down in the control plan⁷. The incoming raw materials may be subjected to controls and tests by the manufacturer before acceptance. Check of incoming materials may include control of inspection documents presented by the manufacturer of the raw materials (comparison with nominal values) by verifying the dimensions and determine the material properties.

The manufactured components of the anchors shall be subjected to the following tests:

- Plastic sleeve made of polyethylene:
 - shape,
 - dimensions (diameter, lengths),
 - markings,
 - properties of polypropylene granules (density, melt mass-flow rate (MFR), DSC-curve),
 - documentation of adjusting data of injection moulding machine,
- Metal expansion pin:
 - shape,
 - dimensions (diameter, lengths),
 - properties of steel (yield limit, tensile strength),
 - thickness of the zinc coating,
- Visual control of correct assemblage and of completeness of the anchors.

The frequency of controls and tests conducted during production and on the assembled anchors is laid down in the control plan⁷ taking account of the manufacturing process of the anchors.

The results of factory production control are recorded and evaluated. The records include at least the following information:

- designation of the product, basic materials and components,
- type of control or testing,
- date of manufacture of the product and date of testing of the product or basic materials or components,
- result of control and testing and, if appropriate, comparison with requirements,

⁷ The control plan has been deposited at Instytut Techniki Budowlanej and may be handed over only to the approved body involved in the conformity attestation procedure.

- signature of person responsible for factory production control.

The records shall be presented to the approved body involved in continuous surveillance. On request they shall be presented to Instytut Techniki Budowlanej. Details of extent, nature and frequency of testing and controls to be performed within the factory production control shall correspond to the control plan⁷ which is part of the technical documentation of this European Technical Approval.

3.2.2 Tasks of the approved body

3.2.2.1 Initial inspection of factory and of factory production control

The approved body shall ascertain that, in accordance with the control plan⁷, the factory, in particular the staff and equipment, and the factory production control are suitable to ensure a continuous and orderly manufacturing of the anchor with the specifications mentioned in 2.1 as well as in the Annexes to the European Technical Approval.

3.2.2.2 Continuous surveillance

Continuous surveillance and assessment of factory production control have to be performed according to the control plan⁷.

The approved body shall visit the factory at least once a year for surveillance. It has to be verified that the system of factory production control and the specified automated manufacturing process are maintained taking account of the prescribed control plan⁷.

The results of continuous surveillance shall be made available on demand by the approved body to Instytut Techniki Budowlanej.

3.3 CE-marking

The CE-marking shall be affixed on each packaging of the anchor. The symbol „CE” shall be accompanied by the following information:

- identification number of the approved body,
- the name or identification mark of the producer (legal entity responsible for the manufacture),
- the number of the EC certificate of the factory production control,
- the number of the ETA,
- the number of the ETAG,
- use categories A, B and C according to ETAG 014,
- the last two digits of the year in which the CE-marking was affixed.

⁷ see page 5

4 Assumptions under which the fitness of the product for the intended use was favorably assessed

4.1 Manufacturing

The anchors are manufactured in accordance with the provisions of the European Technical Approval using the manufacturing process as identified in the inspection of the plant by Instytut Techniki Budowlanej.

The ETA is issued on the basis of agreed data/information, deposited with Instytut Techniki Budowlanej, which identifies the product that has been assessed and judged. Changes to the product or production process, which could result in this deposited data/information being incorrect, should be notified to Instytut Techniki Budowlanej before the changes are introduced. Instytut Techniki Budowlanej will decide whether or not such changes affect the ETA and consequently the validity of the CE marking on the basis of the ETA and if so whether further assessment or alterations to the ETA shall be necessary.

4.2 Installation

4.2.1 Design of anchorages

4.2.1.1 General

The ETA only applies to the manufacture and use of the anchors. Verification of stability of the external thermal insulation composite system including application of loads on the anchor and on the additional plate is not subject of this European Technical Approval.

Fitness for the intended use of the anchors is given under the following conditions:

- the design of anchorages is carried out in compliance with Guideline for European Technical Approval of "*Plastic Anchors for Fixing of External Thermal Insulation Composite Systems with Rendering*", ETAG 014, under the responsibility of an engineer experienced in anchorages,
- verifiable calculation notes and drawings shall be prepared taking account of the loads to be anchored, the nature and strength of the base materials, the thickness of insulation and the dimensions of the anchorage members as well as of the relevant tolerances.

Proof of direct local application of load on the base material has been delivered.

4.2.1.2 Resistance





The characteristic values of the tension resistance of the anchors are given in Table 5, Annex 4. If there is a difference to the given characteristic values of the base material or there is a similar base material of category B and C supposed to be used, the job-site tests according to 4.2.3 shall be carried out and the characteristic tension resistance shall be determined.

4.2.1.3 Characteristic values, spacing and dimensions of anchorage member

The minimum spacing and dimensions of anchorage member according to Annex 3 shall be observed.

4.2.1.4 Displacement behavior

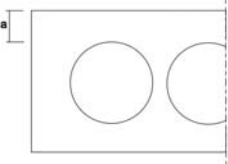
When loaded to the design values of resistance the displacements δ are given in the following table:

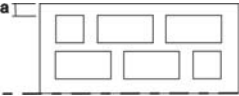
Base material	Bulk density [kg/dm ³]	Compressive strength [N/mm ²]	$\frac{N_{Rk}}{3}$, [kN]	$\delta\left(\frac{N_{Rk}}{3}\right)$, [mm]
Concrete C20/25	–	–	0,4	0,80
Concrete C50/60	–	–	0,5	0,85
Clay brick 	≥ 1,70	≥ 30,0	0,4	1,00
Calcium silicate brick (for example Kalksandstein KS NF 20-2.0 Vollstein according to DIN 106) 	≥ 2,00	≥ 20,0	0,5	0,98
Calcium silicate hollow block (for example Kalksandstein KS L-R(P) 8 DF Lochstein according to DIN 106)  a ¹⁾ = 30 mm 	≥ 1,60	≥ 12,0	0,4	0,90
Perforated ceramic brick (for example Hz B – 1.0 1NF 12-1 according to DIN 105)  a ¹⁾ = 13 mm 	≥ 0,95	≥ 12,0	0,2	0,61

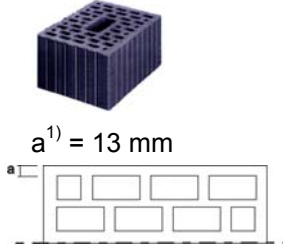
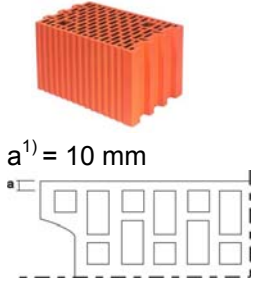
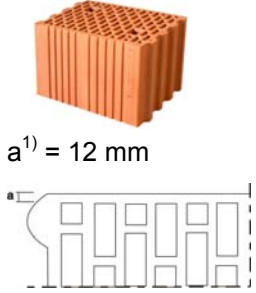
Base material	Bulk density [kg/dm ³]	Compressive strength [N/mm ²]	$\frac{N_{Rk}}{3}$, [kN]	$\delta\left(\frac{N_{Rk}}{3}\right)$, [mm]
Perforated ceramic brick (for example Hlz B – 1.0 3NF 12-1 according to DIN 105)  a ¹⁾ = 13 mm	≥ 0,95	≥ 12,0	0,2	0,62
Vertical perforated porosited block (for example Porotherm 25 P+W)  a ¹⁾ = 10 mm	≥ 0,80	≥ 15,0	0,2	0,46
Vertical perforated ceramic block (for example MEGA-MAX 250)  a ¹⁾ = 12 mm	≥ 0,80	≥ 15,0	0,2	0,61
¹⁾ Minimum values "a". For elements with lower value of "a" the load tests on the construction are required				

4.2.1.5 Point thermal transmittance according EOTA Technical Report TR 025

The point thermal transmittance (CHI-value) of the anchor according EOTA Technical Report TR 025 "Determination of point thermal transmittance of plastic anchors for the anchorage of external thermal insulation composite systems (ETICS)" is given in the following Table:

Anchor type	Insulation thickness H_D [mm]	Point of thermal transmittance χ [W/K]
WK THERM ϕ 8	60 – 320	0,002

4.2.1.6 Plate stiffness according to EOTA Technical Report TR 026

The plate stiffness of the anchor according to EOTA Technical Report TR 026 “*Evaluation of plate stiffness from plastic anchors for fixing of external thermal insulation composite systems with rendering (ETICS)*” is given in the following table:

Anchor type	Diameter of the anchor plate d_{plate} [mm]	Load resistance of the anchor plate $N_{u,m}$ [kN]	Plate stiffness $N_{0,m}$ [kN/mm]
WK THERM ϕ 8	60	4,3	0,6

4.2.2 Installation of anchor

The fitness for use of the anchor can only be assumed if the following conditions of installation are met:

- anchor installation carried out by appropriately qualified personnel under the supervision of the person responsible for technical matters on site,
- use of the anchor only as supplied by the manufacturer without exchanging any component of the anchor,
- anchor installation in accordance with the manufacturer's specifications and drawings using the tools indicated in this European Technical Approval,
- checks before placing the anchor, to ensure that the characteristic values of the base material in which the anchor is to be placed, is identical with the values, which the characteristic loads apply for,
- observation of the drill method (drill holes in concrete and in masonry made of clay bricks and calcium silicate bricks may be drilled using the rotary – impact drill and drill holes in masonry made of other bricks and blocks mentioned in Table 5, Annex 4 may be drilled using the rotary driller),
- temperature during installation of the anchor $\geq 0^\circ\text{C}$.

4.2.3 Job site tests

The characteristic tension resistance of the anchor may be determined by means of job site pull-out tests carried out on the material actually used, if a characteristic resistance of the base material does not exist.

The characteristic resistance of the anchor shall be determined by carrying out at least 15 centric tension load pull-out tests on site. These tests are also possible under the same conditions in a laboratory.

Execution and evaluation of the tests as well as the issue of the test report and the determination of the characteristic resistance should be under the responsibility of approved testing laboratory or the supervision of the person responsible for the execution of the works on site.

Number and position of the anchors to be tested shall be adapted to the relevant special conditions of the site and, for example, to be increased in the case of hidden and larger areas, such that reliable information about the characteristic resistance of

the anchor in the base material in question can be derived. The tests shall take into account the most unfavorable conditions of the practical execution.

4.2.3.1 Assembly

The anchor to be tested shall be installed and the spacing and the edge distances shall be in the same way as planned for the fixing of the external thermal insulation composite system.

Depending on the drilling tool and according to ISO 5468, hard metal hammer-drill bits or hard metal percussion drill bits, respectively, shall be used. The cutting diameter shall be at the upper tolerance limit.

4.2.3.2 Execution of test

The test rig used for the pull-out tests shall provide a continuous slow increase of the load, controlled by a calibrated load cell. The load shall be applied perpendicular to the surface of the base material and shall be transmitted to the anchor via a hinge. The reaction forces shall be transmitted into the base material at a distance of at least 15 cm from the anchor. The load shall be increased continuously in a way, that the ultimate load is reached after about 1 minute. The load is measured when the ultimate load (N_1) is achieved.

4.2.3.3 Test report

The test report shall include all information necessary to assess the resistance of the tested anchor. It shall be included in the construction work dossier.

The minimum data required are:

- construction site, owner of building, date and location of the tests, air temperature, ETICS to be fixed,
- masonry (type of brick, strength class, all dimensions of bricks, mortar group), visual assessment of masonry (flush joints joint clearance regularity),
- plastic sleeve and metal expansion pin, value of the cutting diameter of hard metal hammer-drill bits, measured before and after drilling,
- test rig, results of tests including the indication of value N_1 ,
- name and signature of person having performed or supervised the test.

4.2.3.4 Evaluation of test results

The characteristic resistance N_{RK1} is derived from the measured values N_1 as follows:

$$N_{RK1} = 0,6 \cdot N_1 \leq 1,5 \text{ kN,}$$

N_1 = the mean value of the five smallest measured values at the ultimate load.

4.2.4 Responsibility of the manufacturer

It is in the responsibility of the manufacturer to ensure that the information on the specific conditions according to 1, 2, 4.2.1, 4.2.2, 5 and Annexes is given to those who are concerned. This information may be made by reproduction of the respective parts of the European Technical Approval. In addition, all installation data shall be shown clearly on the packaging and/or on an enclosed instruction sheet, preferably using illustrations.

The minimum data required are:

- base material for the intended use,

- drill bit diameter,
- maximum thickness of the ETICS,
- minimum effective anchorage depth,
- minimum hole depth,
- information on the installation procedure,
- identification of the manufacturing batch.

All data shall be presented in a clear and explicit form.

5 Recommendations for the manufacturer

5.1 Recommendations on packaging, transport and storage

The anchor shall only be packaged and supplied as a complete unit.

The anchor shall be stored under normal climatic conditions. Before installation, it shall not be extremely dried nor frozen.

On behalf of Instytut Techniki Budowlanej



Marek Kaproń
Director of ITB

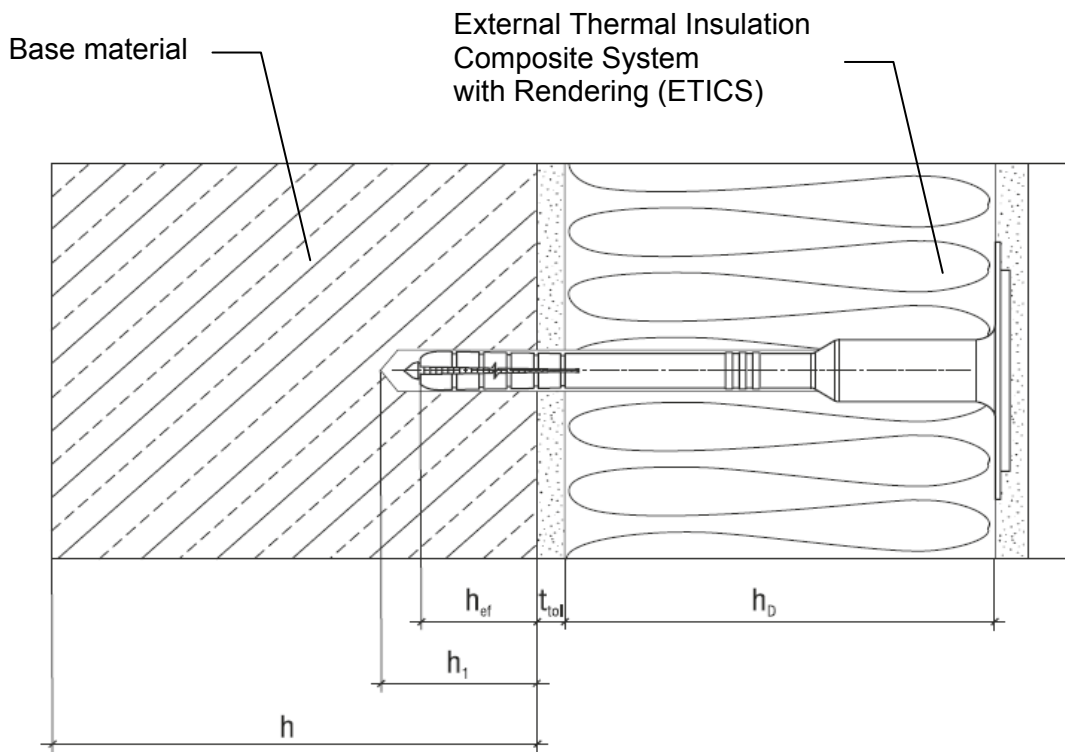

Intended Use

Fixing of external thermal insulation composite systems in concrete and in masonry

Legend

h_{ef} = effective anchorage depth

h_1 = depth of drill hole in base material

h = thickness of base material

h_D = thickness of insulation material

t_{tol} = thickness of equalizing and/or non-load-bearing layer

WK THERM $\phi 8$	Annex 1 of European Technical Approval ETA-11/0232
Intended use	

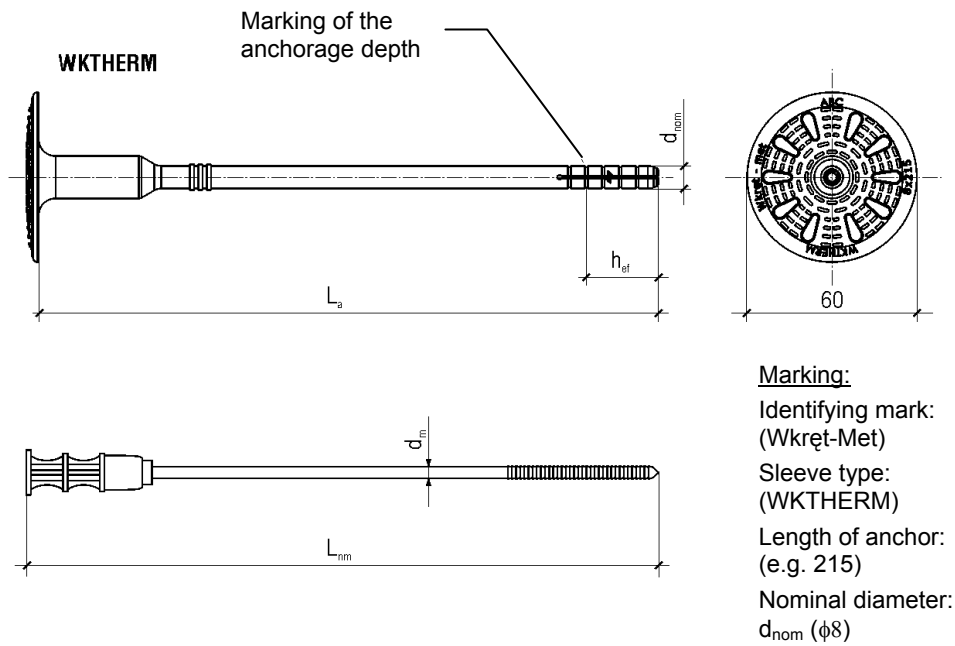

Table 1: WKTHERM $\phi 8$ anchor types and dimensions [mm]

Anchor type	Anchor sleeve			Expansion pin	
	d_{nom}	L_a	h_{ef}	d_m	L_{nm}
WKTHERM $\phi 8$ x 95	8	95	25	4,35	105
WKTHERM $\phi 8$ x 115	8	115	25	4,35	125
WKTHERM $\phi 8$ x 135	8	135	25	4,35	145
WKTHERM $\phi 8$ x 155	8	155	25	4,35	165
WKTHERM $\phi 8$ x 175	8	175	25	4,35	185
WKTHERM $\phi 8$ x 195	8	195	25	4,35	205
WKTHERM $\phi 8$ x 215	8	215	25	4,35	225
WKTHERM $\phi 8$ x 235	8	235	25	4,35	245
WKTHERM $\phi 8$ x 255	8	255	25	4,35	265
WKTHERM $\phi 8$ x 275	8	275	25	4,35	285
WKTHERM $\phi 8$ x 295	8	295	25	4,35	305
WKTHERM $\phi 8$ x 315	8	315	25	4,35	325
WKTHERM $\phi 8$ x 335	8	335	25	4,35	345
WKTHERM $\phi 8$ x 355	8	355	25	4,35	365

Determination of maximum thickness of insulation material: $h_D = L_a - t_{tol} - h_{ef}$

WKTHERM$\phi 8$	Annex 2 of European Technical Approval ETA-11/0232
WKTHERM $\phi 8$ Types and dimensions	

Table 2: Materials

Designation	Material
Anchor sleeve	Polyethylene, natural or grey
Expansion pin	Carbon steel ($f_{y,k} = 235$ MPa, $f_{u,k} = 360$ MPa) galvanised ≥ 5 μm according to EN ISO 4042, with head covered by polyamide PA6 (natural or grey)

Table 3: Installation characteristics

Anchor type		WK THERM ϕ 8
Nominal diameter of drill bit	d_o [mm]	8
Cutting diameter of drill bit	d_{cut} [mm]	$\leq 8,45$
Depth of drill hole	h_1 [mm]	≥ 35
Effective anchorage depth	h_{ef} [mm]	≥ 25

Table 4: Minimum thickness of base material, edge distance and anchor spacing

Anchor type		WK THERM ϕ 8
Minimum thickness of base material	h [mm]	100
Minimum spacing	s_{min} [mm]	100
Minimum edge distance	c_{min} [mm]	100

Diagram of spacing

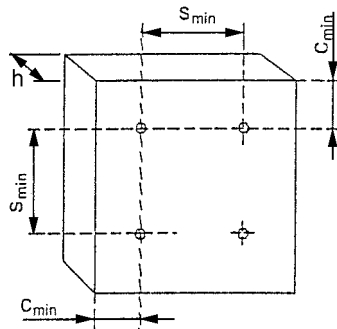





WK THERM ϕ 8

Materials, installation characteristics,
 minimum thickness of base material,
 edge distance and spacing

Annex 3

of European
 Technical Approval
 ETA-11/0232

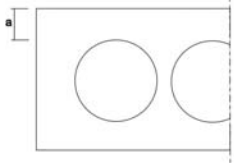
Table 5: Characteristic resistance to tension loads N_{Rk} , kN in concrete and in masonry for single anchor

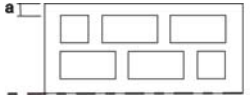



Base material	Bulk density [kg/dm ³]	Min. compressive strength [N/mm ²]	Referring standard	N_{Rk} [kN]
Concrete C12/15			EN 206-1	1,2
Concrete C16/20 ÷ C50/60			EN 206-1	1,5
Clay brick 	≥ 1,70	30,0	EN 771-1	1,5
Calcium silicate brick (for example Kalksandstein KS NF 20-2.0 Vollstein according to DIN 106) 	≥ 2,00	20,0	EN 771-2	1,5
Calcium silicate hollow block (for example Kalksandstein KS L-R(P) 8 DF Lochstein according to DIN 106)  $a^1) = 30 \text{ mm}$ 	≥ 1,60	12,0	EN 771-2	1,2
Perforated ceramic brick (for example Hz B – 1.0 1NF 12-1 according to DIN 105)  $a^1) = 13 \text{ mm}$ 	≥ 0,95	12,0	EN 771-1	0,6

WK THERMφ8

Characteristic resistance

Annex 4
of European
Technical Approval
ETA-11/0232

Extension of Table 5

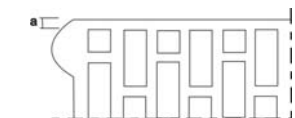
Base material	Bulk density [kg/dm ³]	Min. compressive strength [N/mm ²]	Referring standard	N _{Rk} [kN]
Perforated ceramic brick for example Hlz B – 1.0 3NF 12-1 according to DIN 105)  a ¹⁾ = 13 mm 	≥ 0,95	12,0	EN 771-1	0,6
Vertical perforated porosited block (for example Porotherm 25 P+W)  a ¹⁾ = 10 mm 	≥ 0,80	15,0	EN 771-1	0,6
Vertical perforated ceramic block (for example MEGA-MAX 250)  a ¹⁾ = 12 mm 	≥ 0,80	15,0	EN 771-1	0,6
Partial safety factor for anchor resistance, γ _M ²⁾	2,0			
¹⁾ Minimum values "a". For elements with lower value of "a" the load tests on the construction are required ²⁾ Valid in absence of national regulations				

WK THERM φ8

Characteristic resistance

Annex 4
 of European
 Technical Approval
 ETA-11/0232

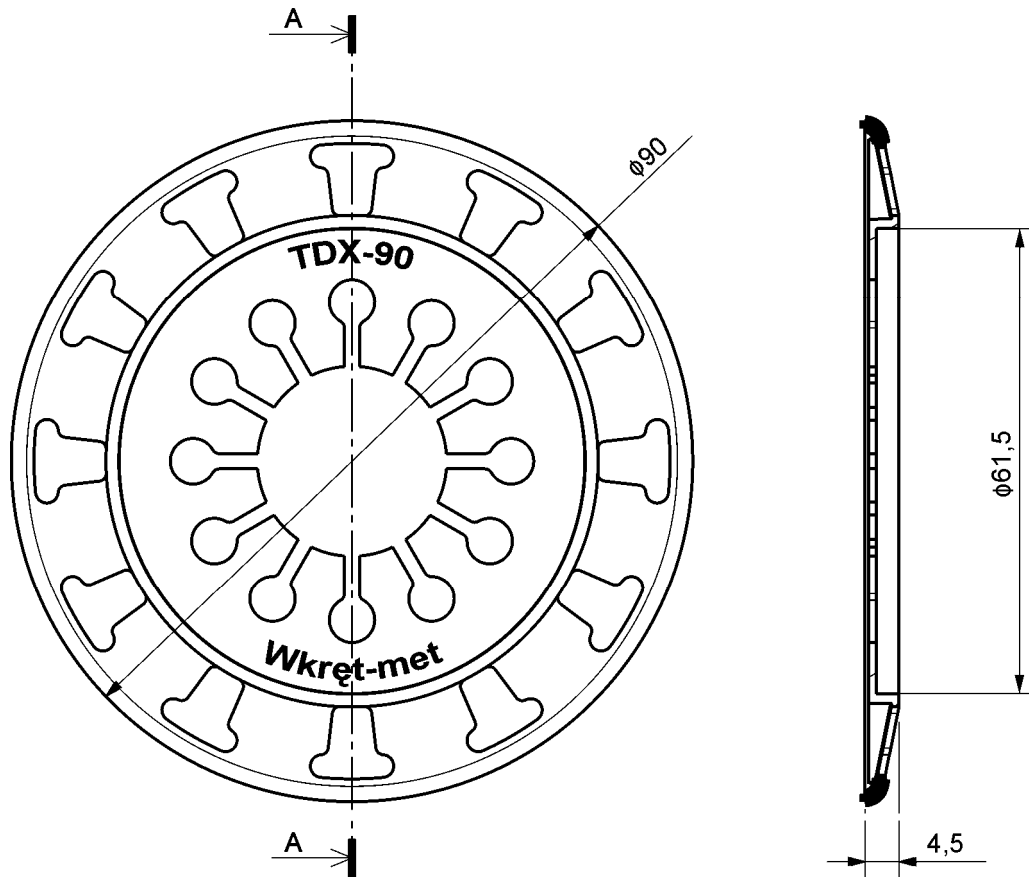

Table 6: Additional plate TDX-90

Plate type	Outer diameter [mm]	Material
TDX-90	90	Polyethylene, natural or grey

WK THERM ϕ 8

Additional plate TDX-90

Annex 5
 of European
 Technical Approval
 ETA-11/0232

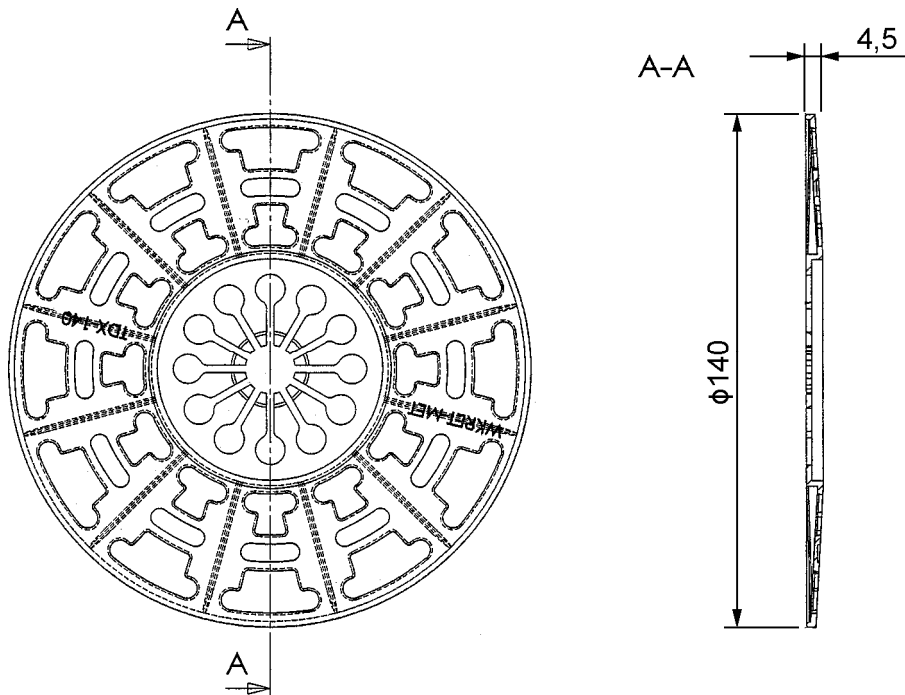

Table 7: Additional plate TDX-140

Plate type	Outer diameter [mm]	Material
TDX-140	140	Polyethylene, natural or grey

WK THERM ϕ 8

Additional plate TDX-140

Annex 6
 of European
 Technical Approval
 ETA-11/0232



Instytut Techniki Budowlanej

ISBN 978-83-249-5518-3